	AMCA Series - Multilayer Chip Antenna Application Note	
Date of Issue: 10/29/15	AMCA31, AMCA52, AMCA62, AMCA72, AMCA81, & AMCA92 Series	
<i>Page (1) of (16)</i>	Abracon Drawing # 453782	Revision #: Revision A

Source Control Drawing

Part Description:	AMCA Series – Multilayer Chip Antenna Application Note
Customer Part Number:	
Abracon Part Number:	AMCA31, AMCA52, AMCA62, AMCA72, AMCA81, & AMCA92 Series

Customer Approval (Please return this copy as a certification of your approval)	
Approved by:	
Approval Date:	

PROPRIETARY NOTICE
 These documents, and the contained information herein, are proprietary and are not to be reproduced, used or disclosed to others for manufacture or for any other purpose, except as specifically authorized, in writing, by ABRACON Corporation.

Abracon Corporation Headquarters:
 30332 Esperanza
 Rancho Santa Margarita, CA-92688
 Ph: (949) 546-8000
 Fax: (949) 546-8001

Internal Use Only	
	500889

Revision History

Revision	ECO	Description	Date	Prep'd By	Ck'd By	Ck'd By	Appr'd By
----		Initial Release	10/16/2013	DC	YH	CB	JE
Rev A	#3079	Revision to Table 4, No-Ground areas	10/29/2015	DC	YH	CB	JE



	AMCA Series - Multilayer Chip Antenna Application Note	
Date of Issue: 10/29/15	AMCA31, AMCA52, AMCA62, AMCA72, AMCA81, & AMCA92 Series	
<i>Page (2) of (16)</i>	Abracon Drawing # 453782	Revision #: Revision A

Table of Contents



1.0 Introduction	3
1.1. Matching and Performance of Evaluation Board	3
2.0 Matching Circuit Layouts & Components	4
2.1. Layout Examples:.....	5
2.2. Matching Chip Antennas for wider bandwidth applications	6
2.2.1 Trade-off between the efficiency and bandwidth	6
2.3. Matching to increase bandwidth	7
2.4. Use of variable matching circuits	8
3.0 Application Recommendations	9
4.0 PCB Layout Tips	10
4.1. Tip No 1: Position of Antennas	10
4.2. Tip No 2: Avoidance of metal plates above or below the keep out area.	10
4.3. Tip No 3: Further examples of good antenna placement schemes.....	11
5.0 Matching process Flow Diagram.....	12
6.0 Evaluation Board Layout.....	13
7.0 Impedance Network Matching	13
7.1. Tuning guides to achieve 50 Ohms match	14
7.2. L-Type Matching rules	14
7.3. Resistive and Conductance areas of a Smith Chart during matching.....	15
7.4. L-Type Matching Example at 2.4GHz	16

List of Figures

Figure (1) – Matching Circuit Options.....	4
Figure (2) – Typical Layout Examples	5
Figure (3) – Efficiency vs. Bandwidth	6
Figure (4) – Critically coupled vs. optimally over-coupled matching.....	7
Figure (5) – Hyperabrupt Varactor Diode variable tuning & matching	8
Figure (6) – Variable tuning response	8
Figure (7) – Good and Bad Antenna placements.....	10
Figure (8) – Avoidance of metal plates.....	10
Figure (9) – Good antenna placements.....	11
Figure (10) – Matching process.....	12
Figure (11) – Evaluation board layout.....	13
Figure (12) – shows ideal matching network that matches input Z and output Z to 50 Ohm.	13
Figure (13) – Tuning guides to achieve 50 Ohm matched impedance	14
Figure (14) – L-Type circuit forbidden regions in Smith charts.....	14
Figure (15) – Resistive and Conductance areas of Smith Chart.....	15
Figure (16) – Example of L-type matching network.....	16

List of Tables

Table (1) – Specification of AMCA	3
Table (2) – Matching Component Values.....	4
Table (3) – Coplanar Waveguide characteristic dimensions (mm).....	5
Table (4) – Dimensions between Antenna and Ground.....	5

	AMCA Series - Multilayer Chip Antenna Application Note	
Date of Issue: 10/29/15	AMCA31, AMCA52, AMCA62, AMCA72, AMCA81, & AMCA92 Series	
<i>Page (3) of (16)</i>	Abracon Drawing # 453782	Revision #: Revision A

1.0 Introduction

This Multilayer Chip Antenna series is designed for the applications covering ISM band, WiFi, Bluetooth & Zigbee at 2.4GHz, China Mobile Multimedia Broadcasting (CMMB - 2635 – 2660) MHz, IMT bands (2.3 ~ 2.4GHz and 2.5 ~ 2.69GHz), and WiMax bands.

These parts offer common features; omni-directional radiation patterns, compact size, light weight and low cost, making them suitable for built-in antenna applications. These antenna designs offer an excellent combination of size, gain and bandwidth, and can be mounted with normal SMT processes.

1.1. Matching and Performance of Evaluation Board

Ceramic Chip Antennas are sensitive to their application environment, such as location of ground planes, the thickness of the PCB layers & dielectric constant and the proximity to other objects. These parameters affect the actual centre frequency, gain and bandwidth of the antenna.



To overcome these influences correct placement and matching circuit composed of L or C, need to be implemented. This means you have to match the antenna into your final products to get the best performance.

The performance characteristics shown in Table (1) are measured on evaluation boards and make up the specification of the parts.

Table (1) – Specification of AMCA

Part No	Size (mm)	Centre Frequency (GHz)	Bandwidth (MHz)	Average Gain (dBi)	Peak Gain (dBi)	VSWR
AMCA31-2R450G-S1F-T	3.2 * 1.6 * 1.2mm	2.45	≥90	-1.0 dBi	0.5dBi	<2:1
AMCA31-2R800G-S1F-T	3.2 * 1.6 * 1.2mm	2.80	≥100	-1.0 dBi	0.5dBi	<2:1
AMCA52-2R350G-S1F-T	5.2 * 2.1 * 1.0mm	2.35	≥150	0.5dBi	2.5dBi	<2:1
AMCA52-2R510G-S1F-T	5.2 * 2.1 * 1.0mm	2.51	≥200	0.5dBi	2.5dBi	<2:1
AMCA52-2R540G-S1F-T	5.2 * 2.1 * 1.0mm	2.54	≥200	0.5dBi	2.5dBi	<2:1
AMCA52-2R710G-S1F-T	5.2 * 2.1 * 1.0mm	2.71	≥200	0.5dBi	2.5dBi	<2:1
AMCA52-2R780G-S1F-T	5.2 * 2.1 * 1.0mm	2.78	≥200	0.5dBi	2.5dBi	<2:1
AMCA62-2R640G-01F-T	6.0 * 2.0 * 1.0mm	2.64	≥200	0.7dBi	2.6dBi	<2:1
AMCA72-2R470G-S1F-T	7.0 * 2.0 * 1.0mm	2.47	≥200	1.0dBi	2.7dBi	<2:1
AMCA72-2R860G-02F-T	7.0 * 2.0 * 1.0mm	2.86	≥200	1.0dBi	2.7dBi	<2:1
AMCA81-3R010G-S1F-T	8.0 * 1.0 * 1.0mm	3.01	≥200	0.5dBi	2.0dBi	<2:1
AMCA92-2R660G-S1F-T	9.0 * 2.0 * 1.0mm	2.66	≥200	1.0dBi	3.0dBi	<2:1

The matching process allows the antenna's centre frequency to reach the target Fo. The AMCA range offers different size and centre frequency choices allowing designers to choose antennas to match the band required and board conditions.

	AMCA Series - Multilayer Chip Antenna Application Note	
Date of Issue: 10/29/15	AMCA31, AMCA52, AMCA62, AMCA72, AMCA81, & AMCA92 Series	
<i>Page (4) of (16)</i>	Abracon Drawing # 453782	Revision #: Revision A

2.0 Matching Circuit Layouts & Components

Chip antenna should be matched with the environment of final products. Normally this process can be done with lumped elements; capacitors or inductors across the range of values in Table (2).

Table (2) – Matching Component Values

Component	Description	Value
Capacitor	* Series C	0.5 ~ 10pF
	* Shunt C	33pF, 100pF
Inductor	Series L	1.0 ~ 6nH
	Shunt L	1.0 ~ 6nH

*Series: Connected between antenna and feeding line in series.

*Shunt: Connected between antenna and feeding line in parallel

Figure (1) – Matching Circuit Options

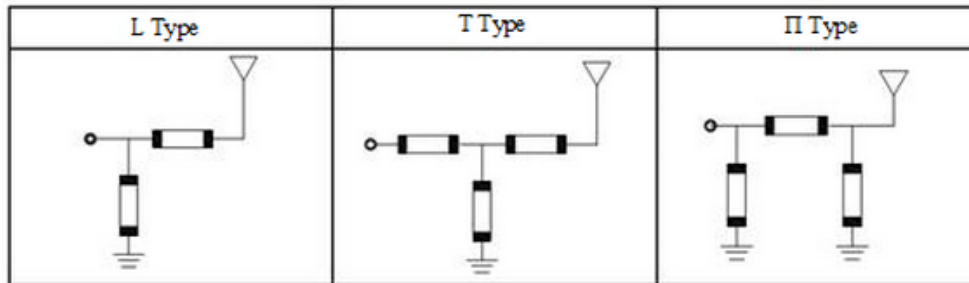

Designers may add flexibility to their PCB design by adopting the π -type circuit layout to the antenna, allowing them to revert to L or T matches as required.

2.1. Layout Examples:

Figure (2) – Typical Layout Examples

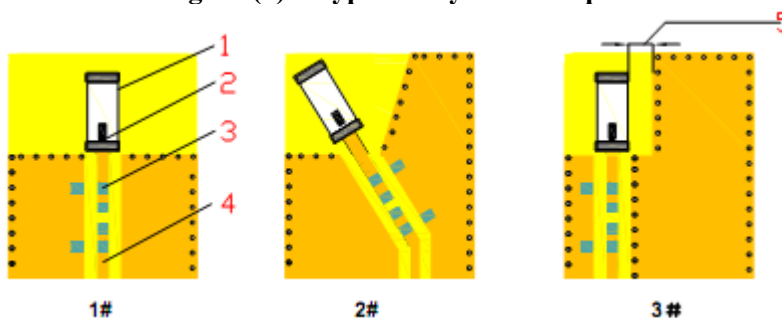

If the PCB space was available, the 1# layout is recommended.

- 1) – Chip antenna
- 2) – Feeding mark
- 3) – Layout pad of the matching circuit
- 4) – 50 ohm transmission line (you can use the tool like ADS or APPCAD etc. to calculate the line width and space size).

For example, if using CPWG, you can use the parameters listed in Table (2.1)

Table (3) – Coplanar Waveguide characteristic dimensions (mm)

Thickness of board	Transmission line width	Space between the transmission line and ground
0.8	0.5	0.15
0.25	0.28	0.15

- 5) – Space between the Antenna and Ground area. Ref dimensions per Table (2.11)

Table (4) – Dimensions between Antenna and Ground

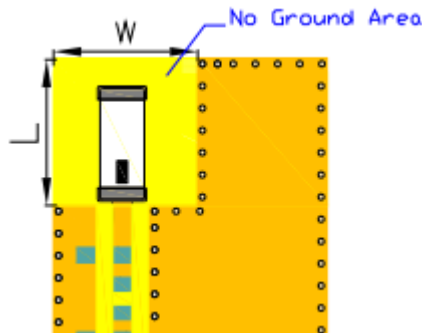
Part Series	Antenna Size (mm)	No Ground Area (min, LxW, mm)	Layout Example
AMCA31	3.2 x 1.6	6.4 x 9.0	
AMCA52	5.2 x 2.0	10.4 x 10.0	
AMCA62	6.0 x 2.0	12.0 x 10.0	
AMCA72	7.0 x 2.0	14.0 x 10.0	
AMCA81	8.0 x 1.0	16.0 x 5.0	
AMCA92	9.0 x 2.0	18.0 x 10.0	

2.2. Matching Chip Antennas for wider bandwidth applications

Reduction in the size chip antennas means that their bandwidth may be reduced if efficiency is to be maintained. This can affect the needed application bandwidth, so alternative tuning options can provide a potential solution:

2.2.1 Trade-off between the efficiency and bandwidth

Figure (3) – Efficiency vs. Bandwidth

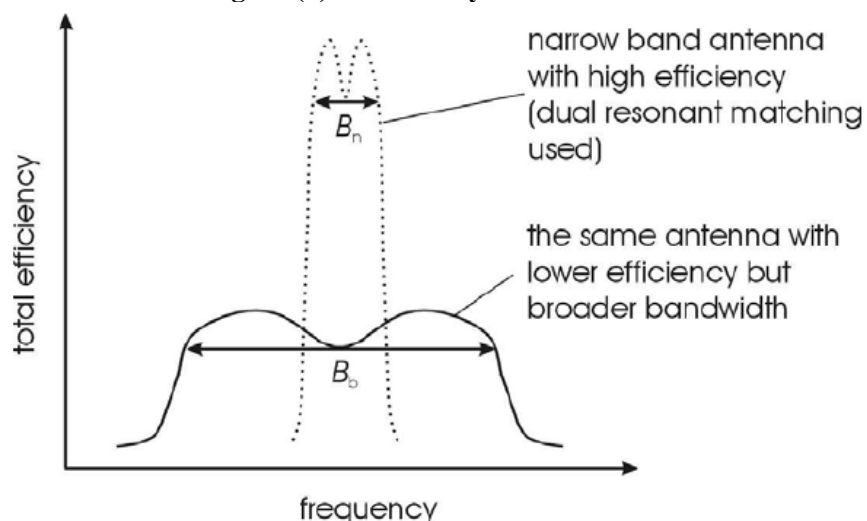

There are basically two options to decrease efficiency:

- Resistive matching
- Accept more mismatch between the antenna and the receiver

For a transmitter antenna, resistive matching might be necessary to meet the requirements of the RF power amplifier to avoid oscillation of the PA stage.

For a receiving antenna, such as a GPS antenna, mismatch between the antenna and the receiver will lead to a broader B/W, but consideration of the SNR could be driven by the Return Loss (S11) matching. This may drop to 1 – 2 dB, and may or may not be acceptable to the RF design.

Date of Issue: 10/29/15

**AMCA31, AMCA52, AMCA62,
 AMCA72, AMCA81,
 & AMCA92 Series**
Page (7) of (16)

Abracon Drawing # 453782

Revision #: Revision A

2.3. Matching to increase bandwidth

The impedance bandwidth can furthermore be increased by:

- Using dual resonant matching, as seen in Figure (4) below.
- Using optimal over-coupling, i.e. the antenna is coupled so that the impedance bandwidth is maximized according to a certain matching criteria.

Figure (4) – Critically coupled vs. optimally over-coupled matching.

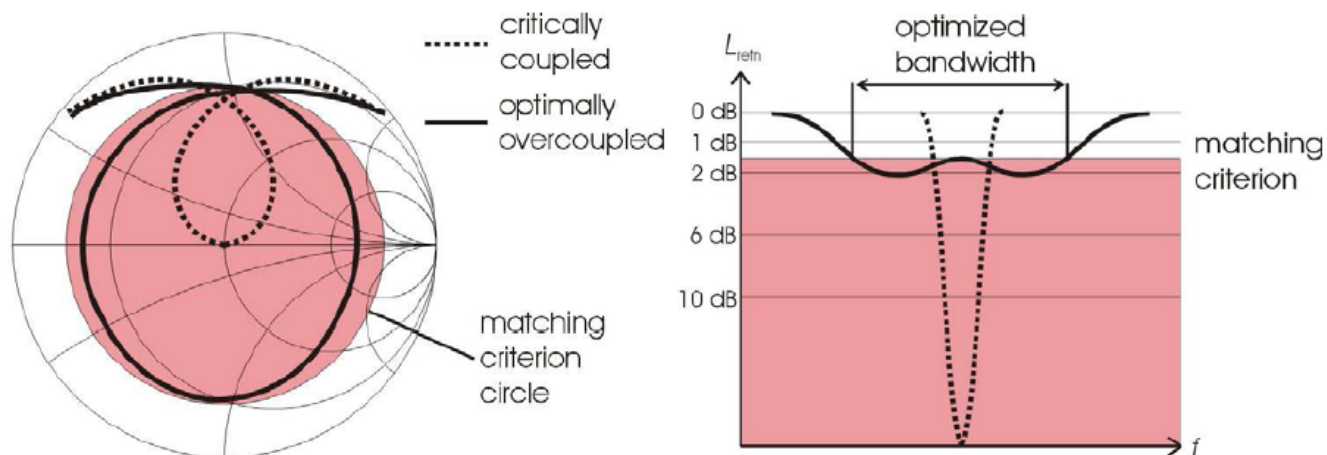

2.4. Use of variable matching circuits

Matching circuits can utilize the varying capacitance, as seen with a Varicap Diodes. This allows designs to implement a tuneable antenna to make the antenna operate across the whole band. Figure (5) shows a tuneable antenna example and Figure (6) its response.

Figure (5) – Hyperabrupt Varactor Diode variable tuning & matching

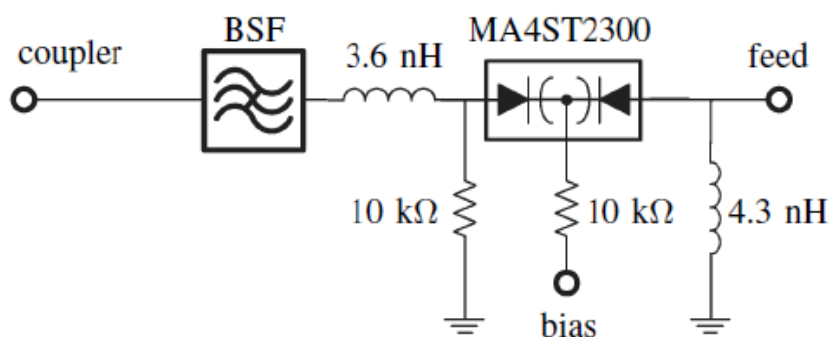

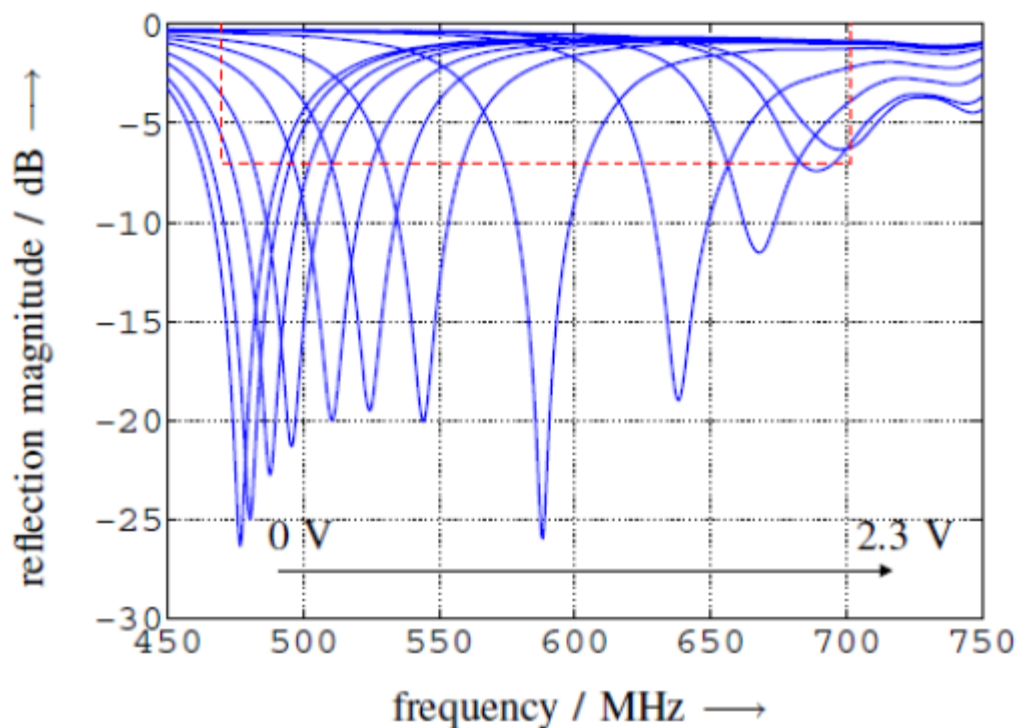

Tunable Matching Circuits

Figure (6) – Variable tuning response





Response with the Tuning

	AMCA Series - Multilayer Chip Antenna Application Note	
Date of Issue: 10/29/15	AMCA31, AMCA52, AMCA62, AMCA72, AMCA81, & AMCA92 Series	
<i>Page (9) of (16)</i>	Abracon Drawing # 453782	Revision #: Revision A

3.0 Application Recommendations

- Antenna gain, bandwidth and efficiency are often larger with larger antennas, so it is often better not to reduce antenna size too much, if board space allows.
- Maintain recommended clearances between the antenna and nearby objects, or the tuning will be very difficult and radiation pattern can be heavily distorted.
- Never place ground plane or tracks underneath the antenna.
- Never place the antenna very close to metallic objects, such as batteries, LCD panel speakers, etc
- Care should be taken about the wiring in the finalized product; avoid conductors too close to the antenna.
- A monopole antenna should have a reasonable ground plane to be efficient.
- Final tuning should be done in the end product, not in free air.
- Never install a chip antenna in a vastly different layout than the reference design, and expect it to work without tuning.
- Do not use a metallic enclosures or metallized plastic over the antenna, as this will distort the RF radiation pattern.
- Test the plastic casing for high RF losses, preferably before production.
- Never use low-Q loading components, or change manufacturer without retesting.
- Do not use very thin PCB tracks, the tracks should be fairly wide, and matched to the antenna.

	AMCA Series - Multilayer Chip Antenna Application Note	
Date of Issue: 10/29/15	AMCA31, AMCA52, AMCA62, AMCA72, AMCA81, & AMCA92 Series	
<i>Page (10) of (16)</i>	Abracon Drawing # 453782	Revision #: Revision A

4.0 PCB Layout Tips

4.1. Tip No 1: Position of Antennas.

Figure (7) – Good and Bad Antenna placements

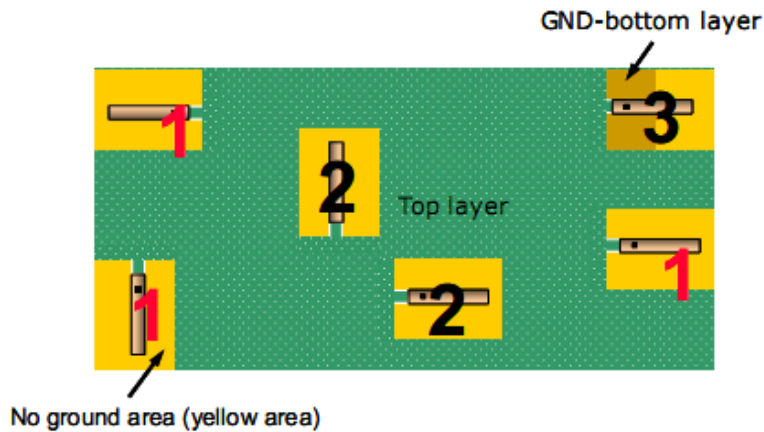



1: Good placement / 2 & 3: Bad placement

4.2. Tip No 2: Avoidance of metal plates above or below the keep out area.

Don't put the metal plate or battery above or below the yellow region. Keep away any other metals from clearance area.

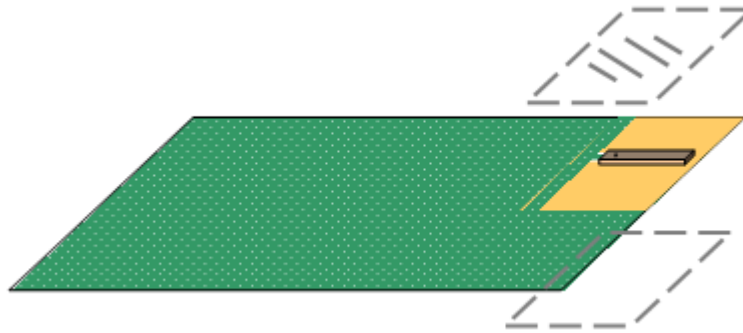
Figure (8) – Avoidance of metal plates





 <p>The Power of Linking Together</p>	<p>AMCA Series - Multilayer Chip Antenna Application Note</p>	
<p>Date of Issue: 10/29/15</p>	<p>AMCA31, AMCA52, AMCA62, AMCA72, AMCA81, & AMCA92 Series</p>	
<p>Page (11) of (16)</p>	<p>Abracon Drawing # 453782</p>	<p>Revision #: Revision A</p>

4.3. Tip No 3: Further examples of good antenna placement schemes.

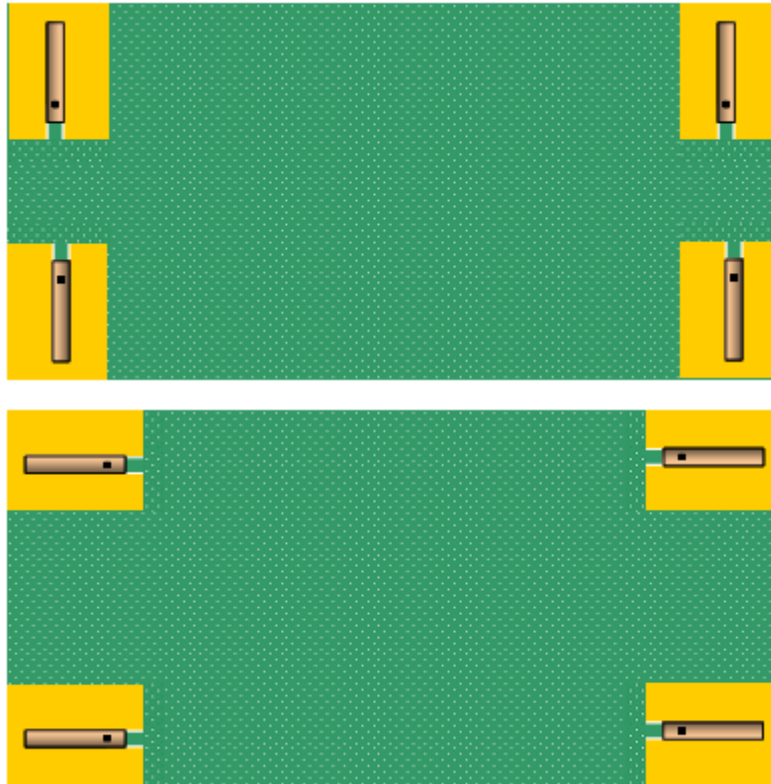
Figure (9) – Good antenna placements



	AMCA Series - Multilayer Chip Antenna Application Note	
Date of Issue: 10/29/15	AMCA31, AMCA52, AMCA62, AMCA72, AMCA81, & AMCA92 Series	
<i>Page (12) of (16)</i>	Abracon Drawing # 453782	Revision #: Revision A

5.0 Matching process Flow Diagram

Figure (10) – Matching process

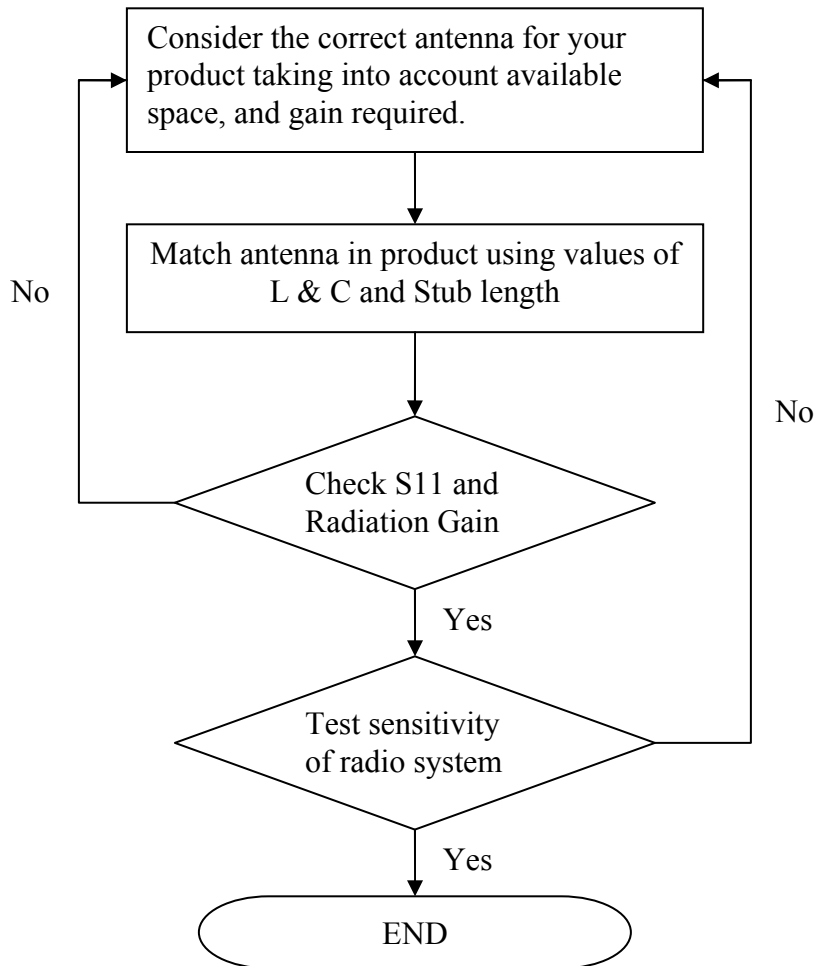

6.0 Evaluation Board Layout

Figure (11) – Evaluation board layout

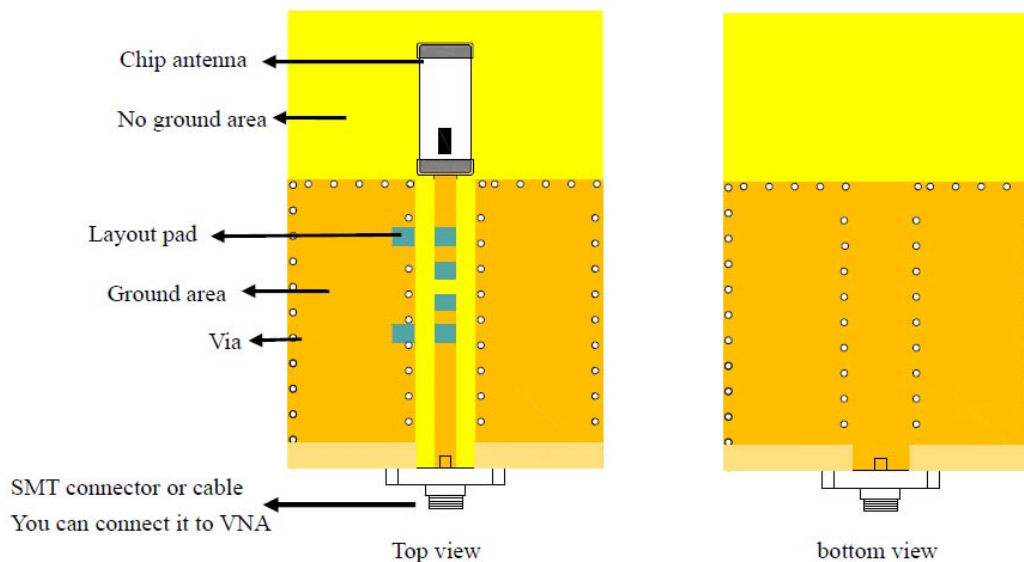

7.0 Impedance Network Matching

Figure (12) – shows ideal matching network that matches input Z and output Z to 50 Ohm.

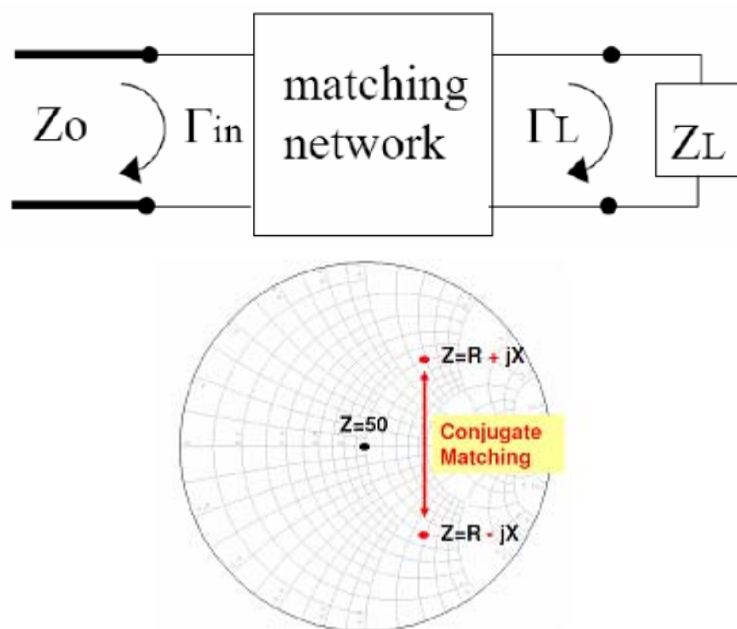

7.1. Tuning guides to achieve 50 Ohms match

Figure (13) – Tuning guides to achieve 50 Ohm matched impedance

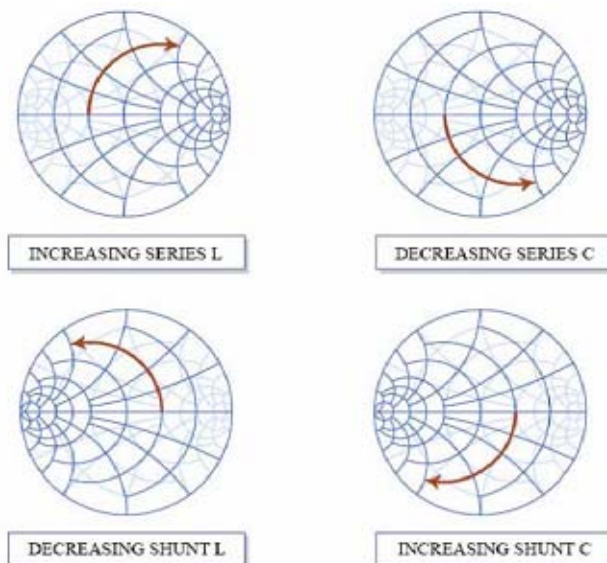

7.2. L-Type Matching rules

Figure (14) – L-Type circuit forbidden regions in Smith charts

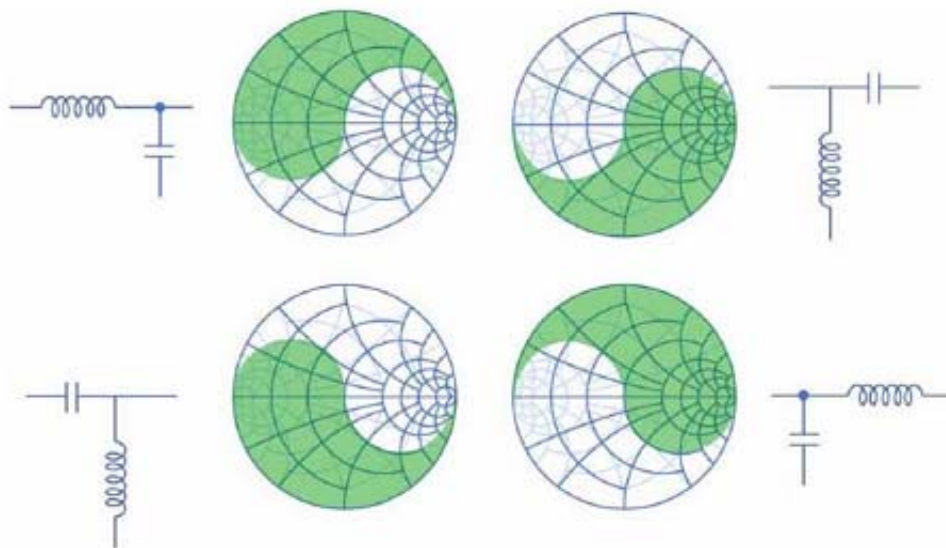

The green shaded areas denote values of load impedance that cannot be matched to 50 Ω

Date of Issue: 10/29/15

**AMCA31, AMCA52, AMCA62,
 AMCA72, AMCA81,
 & AMCA92 Series**
Page (15) of (16)

Abracon Drawing # 453782

Revision #: Revision A

7.3. Resistive and Conductance areas of a Smith Chart during matching.

Figure (15) – Resistive and Conductance areas of Smith Chart.

Region 1	Region 2	Region 3	Region 4
Low resistance or high conductance	High resistance or low conductance	Low resistance and low conductance	Low resistance and low conductance

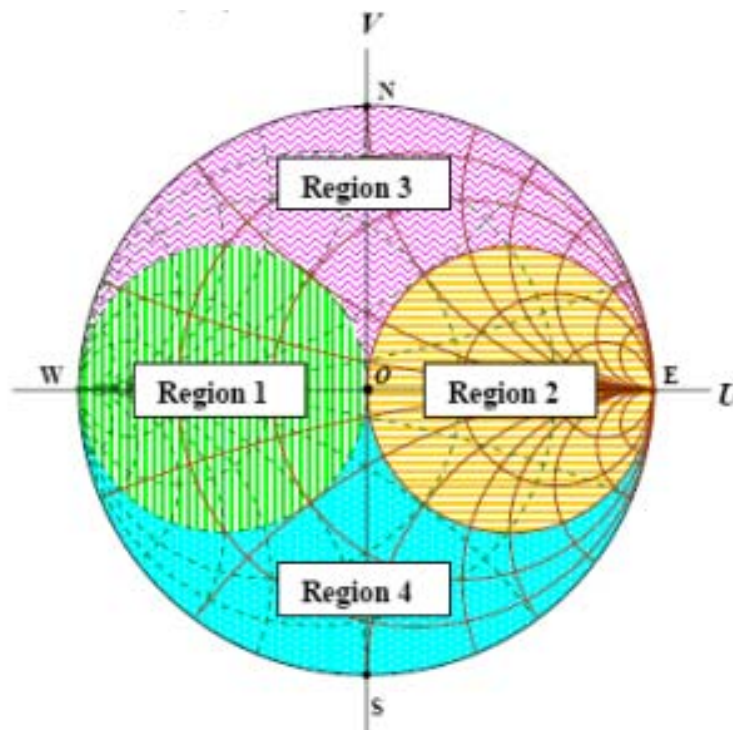

Date of Issue: 10/29/15

**AMCA31, AMCA52, AMCA62,
AMCA72, AMCA81,
& AMCA92 Series**

Page (16) of (16)

Abracon Drawing # 453782

Revision #: Revision A

7.4. L-Type Matching Example at 2.4GHz

Figure (16) – Example of L-type matching network
