

Molding Type Power Inductor

ASPI-1040HI

MSL level: 2 (This product is packed by dry packaging)



RoHS
Compliant



11.15 x 10.0 x 4.0 mm

FEATURES:

- High saturation current.
- Low loss due to low DC resistance.
- Frequency application up to 3MHz.
- Low profile with max thickness 4.0mm.
- 100% lead free and metted RoHS standard.
- Suitable for reflow soldering.
- High reliable SMD package

APPLICATIONS:

- DC/DC converters in Notebook, Netbook, desktop and server
- Low profile, high current power supplies.

STANDARD SPECIFICATIONS

Abrakon P/N:	ASPI-1040HI Series
Operating Temperature & Humidity:	-55°C to +125°C (Including self generated heat)
Storage Temperature & Humidity:	+25°C to +35°C, 45% to 85% RH

Part Number	Inductance	Tolerance	DCR Typ	DCR Max	Saturation Current	Temperature Rise Current
Units	μH	%	mΩ	mΩ	A	A
Symbol	L	M			Isat*	Irms*
ASPI-1040HI-R16	0.16	M	0.50	0.65	75.0	40.0
ASPI-1040HI-R22	0.22	M	0.88	0.96	68.0	35.0
ASPI-1040HI-R47	0.47	M	1.55	1.70	40.0	30.0
ASPI-1040HI-1R0	1.00	M	3.00	3.30	28.0	18.0
ASPI-1040HI-4R7	4.70	M	17.00	20.20	15.0	8.5
ASPI-1040HI-100	10.00	M	27.00	30.00	8.5	7.5

Test Conditions

Inductance is measured in HP-4284A Precision LCR Meter.

RDC is measured in HP-4338B milli ohm meter.(or equivalent).

. Isat: Based on inductance change ($\Delta L/L_0 : \leq -20\%$)

. Irms: Based on temperature rise ($\Delta T : 40^\circ\text{C TYP.}$)

ELECTRICAL CHARACTERISTIC CURVES

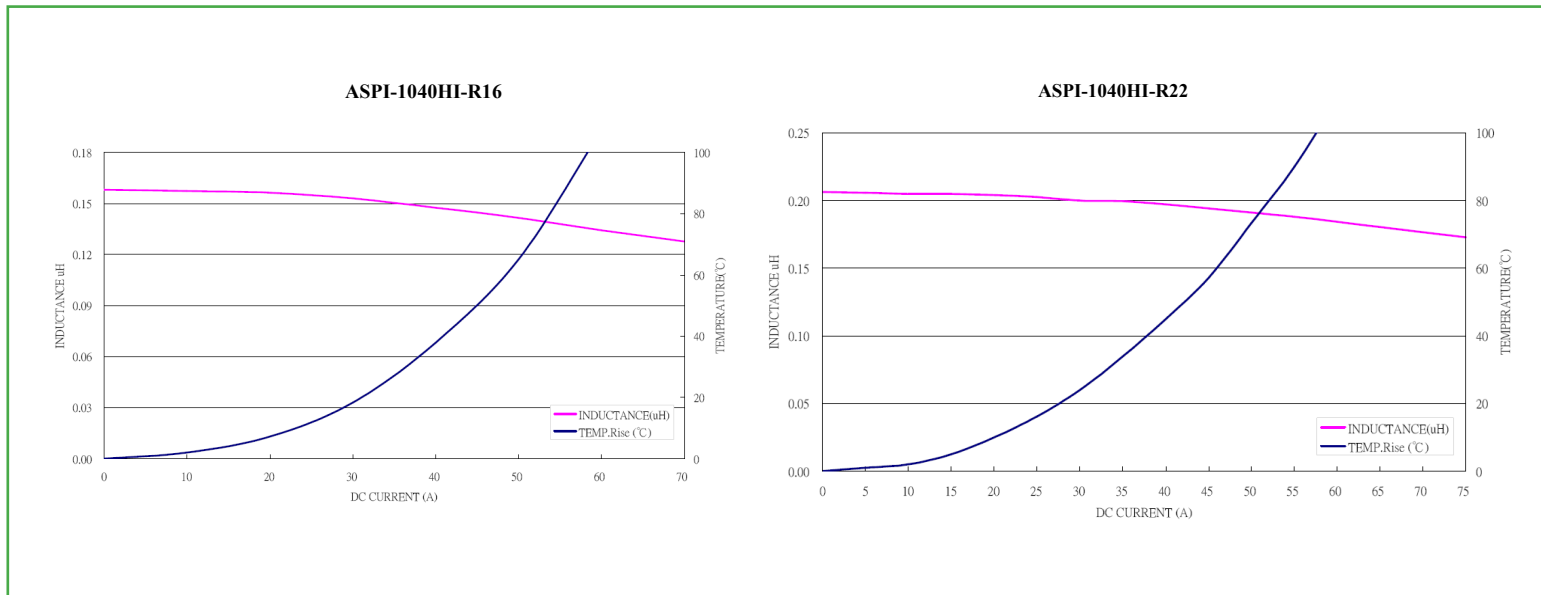

ABRACON IS
ISO 9001:2008
CERTIFIED



Visit www.abracon.com for Terms & Conditions of Sale

Revised: 11.19.11

30332 Esperanza, Rancho Santa Margarita, California 92688
tel 949-546-8000 | fax 949-546-8001 | www.abracon.com

Molding Type Power Inductor

ASPI-1040HI



RoHS
Compliant



11.15 x 10.0 x 4.0 mm

ELECTRICAL CHARACTERISTIC CURVES

ASPI-1040HI-R47

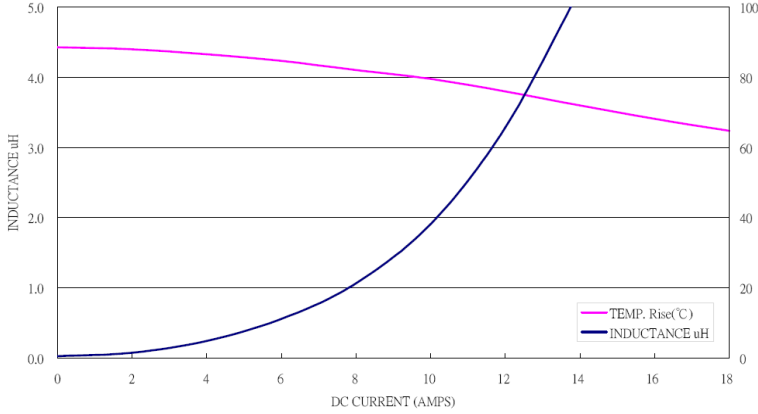

ASPI-1040HI-1R0

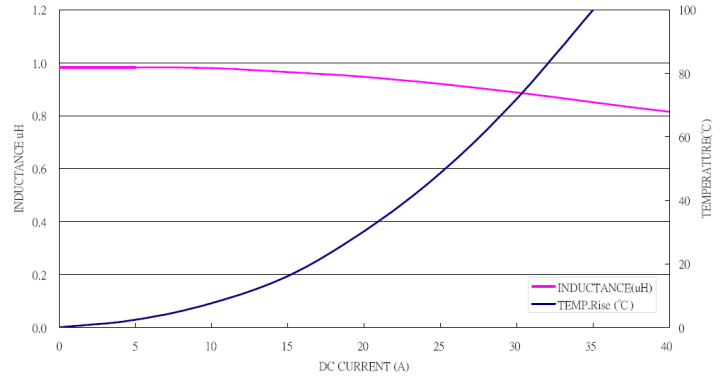

ASPI-0630HI-4R7

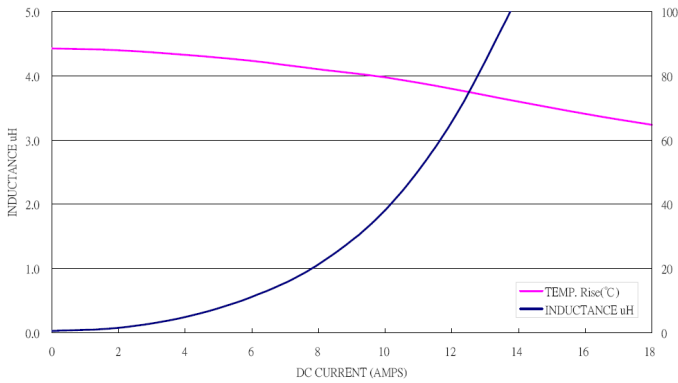

ASPI-1040HI-100

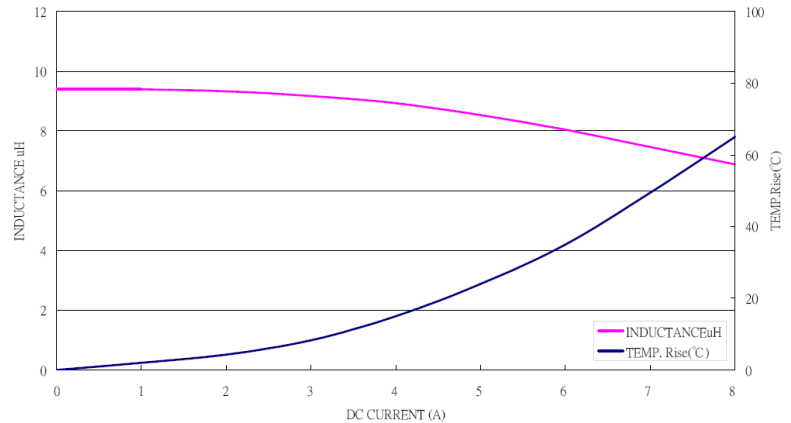

Molding Type Power Inductor

ASPI-1040HI



RoHS
Compliant



11.15 x 10.0 x 4.0 mm

PART NUMBER IDENTIFICATION

ASPI-1040HI- -

Inductance Code

Please refer to the
Electrical Spec Table

Tolerance

M: $\pm 20\%$

Packaging

T05: Tape and Reel (500pcs /
reel)

OUTLINE DRAWING:



A	A'	B	L	W	H
2.0 \pm 0.5	2.5 \pm 0.1	3.0 \pm 0.5	11.15 \pm 0.35	10 \pm 0.3	4 max (4.0 \pm 0.25 for R16)

Recommended Land Pattern

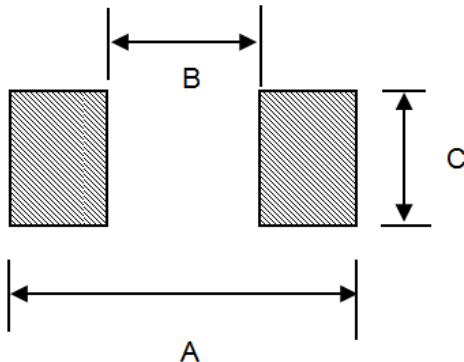

A	B	C
13.6	5.4	4.1

Dimension: mm

Molding Type Power Inductor

ASPI-1040HI



RoHS
Compliant



11.15 x 10.0 x 4.0 mm

TAPE & REEL:

T05: 500pcs / reel

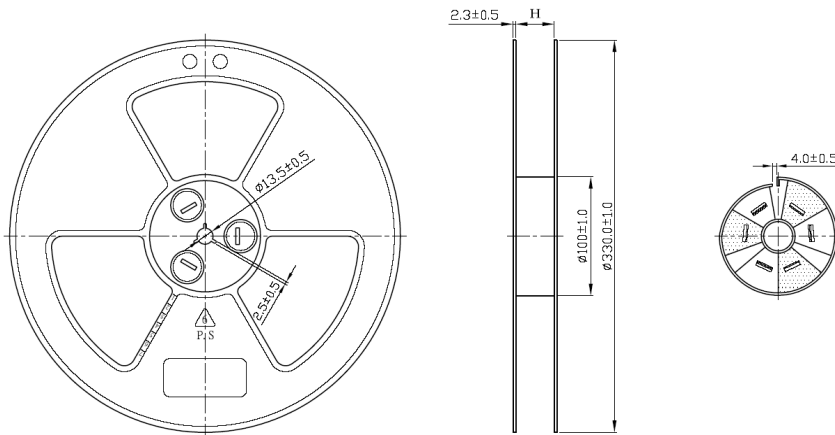
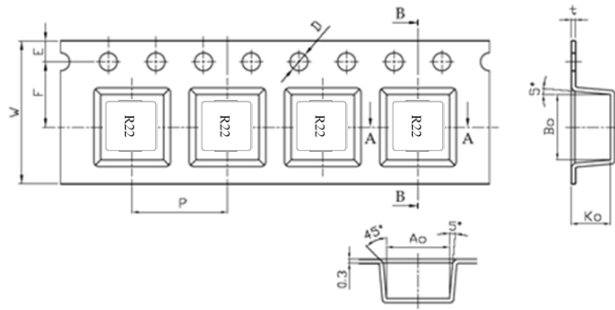

A0	10.5
B0	11.5
K0	4.2
P	16.0
t	0.5
W	24
E	1.75
F	11.5
D	1.5

Dimension: mm

REFLOW PROFILE:

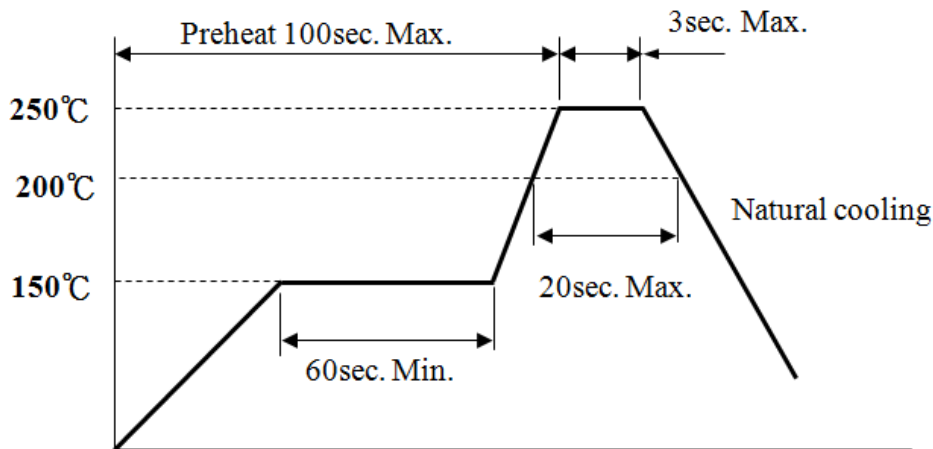

ATTENTION: Abracon Corporation's products are COTS – Commercial-Off-The-Shelf products; suitable for Commercial, Industrial and, where designated, Automotive Applications. Abracon's products are not specifically designed for Military, Aviation, Aerospace, Life-dependant Medical applications or any application requiring high reliability where component failure could result in loss of life and/or property. For applications requiring high reliability and/or presenting an extreme operating environment, written consent and authorization from Abracon Corporation is required. Please contact Abracon Corporation for more information.

ABRACON IS
ISO 9001:2008
CERTIFIED



Visit www.abracon.com for Terms & Conditions of Sale

30332 Esperanza, Rancho Santa Margarita, California 92688
tel 949-546-8000 | fax 949-546-8001 | www.abracon.com

Revised: 11.19.11