

# Molding Type Power Inductor

ASPI-0530LR

MSL level: 2 (This product is packed by dry packaging)



RoHS  
Compliant



5.6 x 5.2 x 3.0 mm

## FEATURES:

- High saturation current.
- Low loss due to low DC resistance.
- Frequency application up to 3MHz.
- Low profile with max thickness 3.0mm.
- 100% lead free and metted RoHS standard.
- Suitable for reflow soldering.
- High reliable SMD package

## APPLICATIONS:

- DC/DC converters in Notebook, Netbook, desktop and server
- Low profile, high current power supplies.

## STANDARD SPECIFICATIONS

Abrakon P/N:	ASPI-0530LR Series
Operating Temperature & Humidity:	-55°C to +125°C (Including self generated heat)
Storage Temperature & Humidity:	+25°C to +35°C, 45% to 85% RH

Part Number	Inductance	Tolerance	DCR Typ	DCR Max	Saturation Current	Temperature Rise Current
Units	μH	%	mΩ	mΩ	A	A
Symbol	L	M			Isat	Irms
ASPI-0530LR-1R5	1.5	M	18.5	20.0	7.0	8.0
ASPI-0530LR-2R2	2.2	M	24.0	26.0	5.5	7.0
ASPI-0530LR-3R3	3.3	M	32.0	36.0	5.0	6.5
ASPI-0530LR-4R7	4.7	M	54.0	60.0	4.5	4.5
ASPI-0530LR-5R6	5.6	M	55.0	65.0	4.0	4.5

## Test Conditions

Inductance is measured in HP-4284A Precision LCR Meter.

RDC is measured in HP-4338B milli ohm meter.(or equivalent).

Isat: Based on inductance change ( $\Delta L/L_o : \leq -20\%$ )

Irms: Based on temperature rise ( $\Delta T : 40^\circ\text{C TYP.}$ )

## ELECTRICAL CHARACTERISTIC CURVES

ASPI-0530LR-1R5

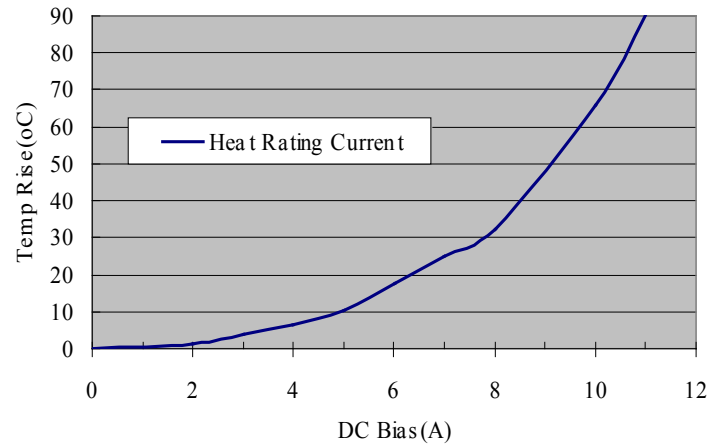
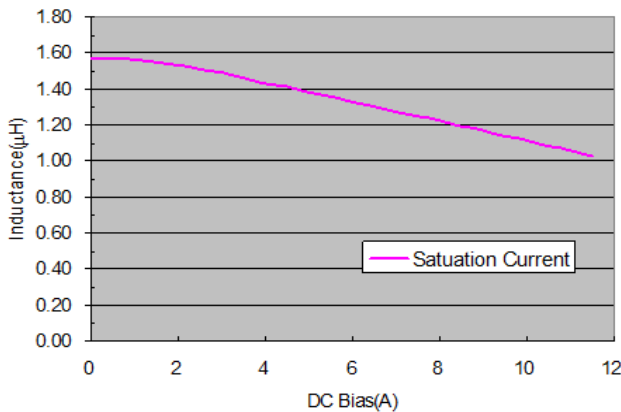

# Molding Type Power Inductor

ASPI-0530LR



5.6 x 5.2 x 3.0 mm

## ELECTRICAL CHARACTERISTIC CURVES

ASPI-0530LR-2R2

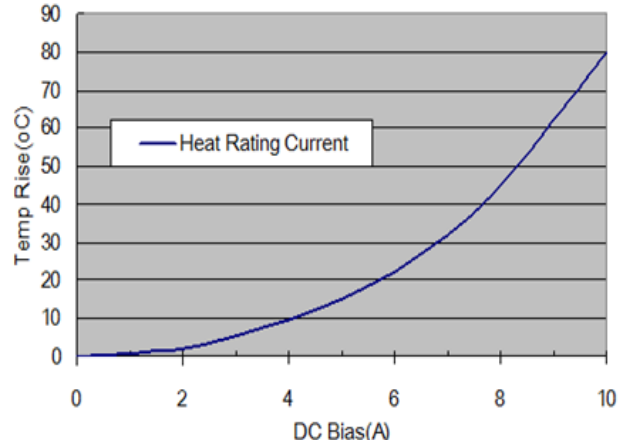
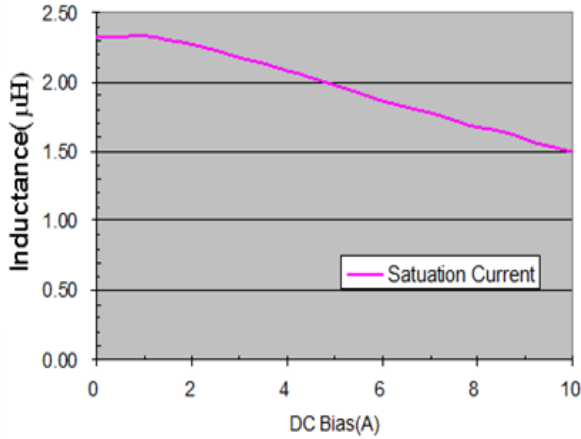

ASPI-0530LR-3R3

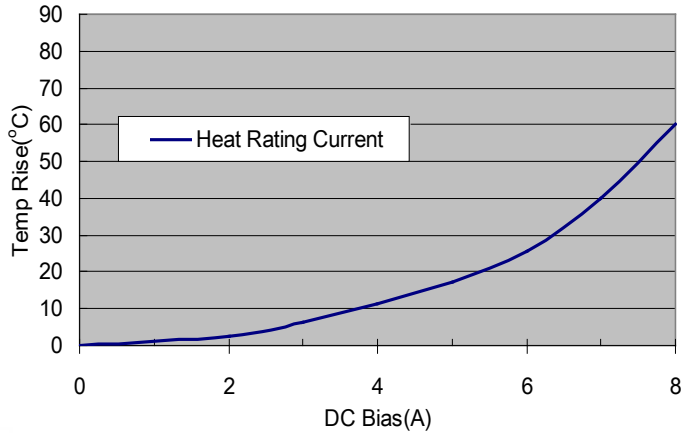
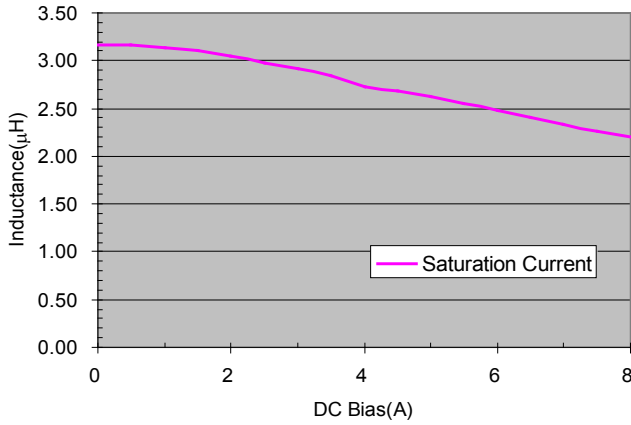

ASPI-0530LR-4R7

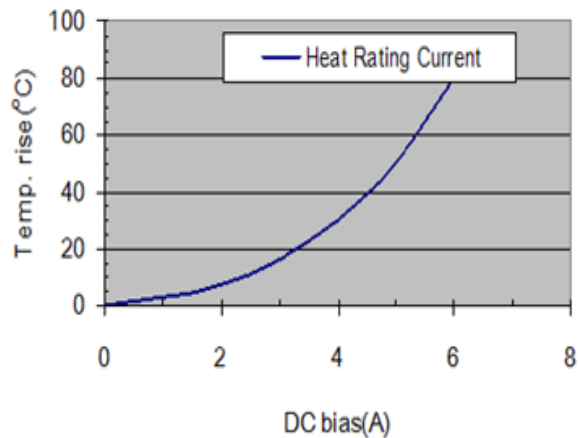
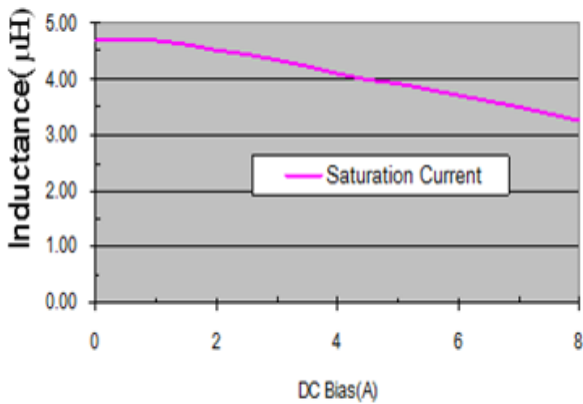

# Molding Type Power Inductor

ASPI-0530LR



5.6 x 5.2 x 3.0 mm

## ELECTRICAL CHARACTERISTIC CURVES

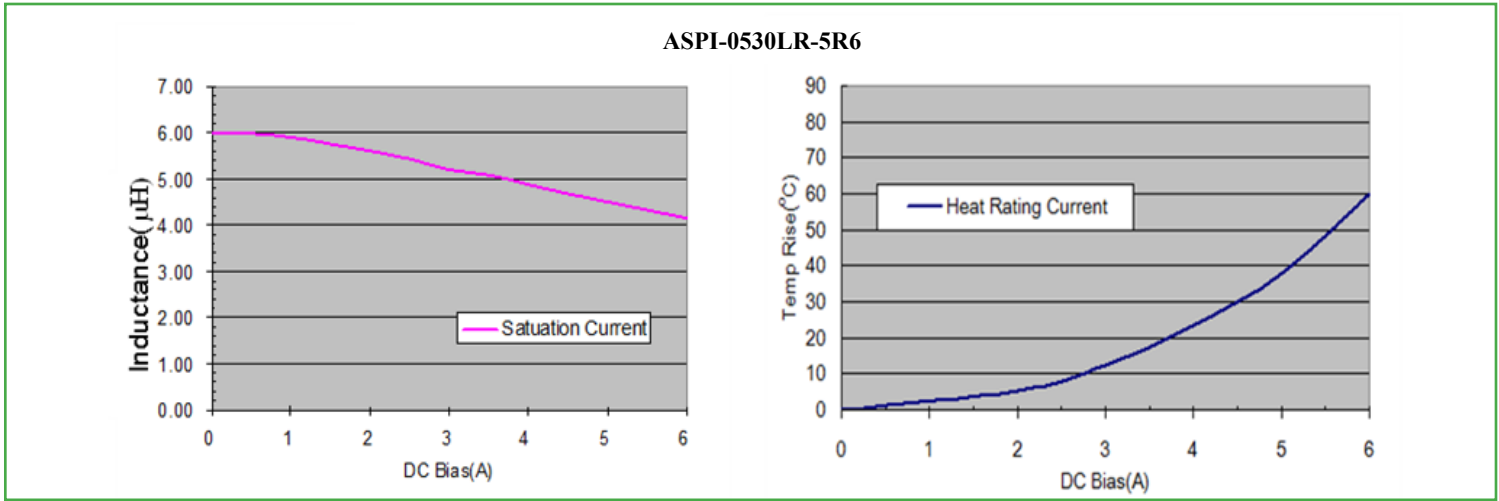

## PART NUMBER IDENTIFICATION

ASPI-0530LR-       -   

<b>Inductance Code</b>	<b>Tolerance</b>	<b>Packaging</b>
Please refer to the Electrical Spec Table	M: ±20%	T2: Tape and Reel (2kpcs / reel)

## OUTLINE DRAWING:

### Recommended Land Pattern

A	A'	B	B'	L	W	H max
1.0 ±0.4	1.5 ±0.1	2.0 ±0.3	2.5 ±0.2	5.60 ±0.35	5.2 ±0.2	3.0

A	B	C
5.99	2.2	2.5

**Dimension: mm**

# Molding Type Power Inductor

ASPI-0530LR



RoHS  
Compliant



5.6 x 5.2 x 3.0 mm

## TAPE & REEL:

T2: 2,000pcs / reel

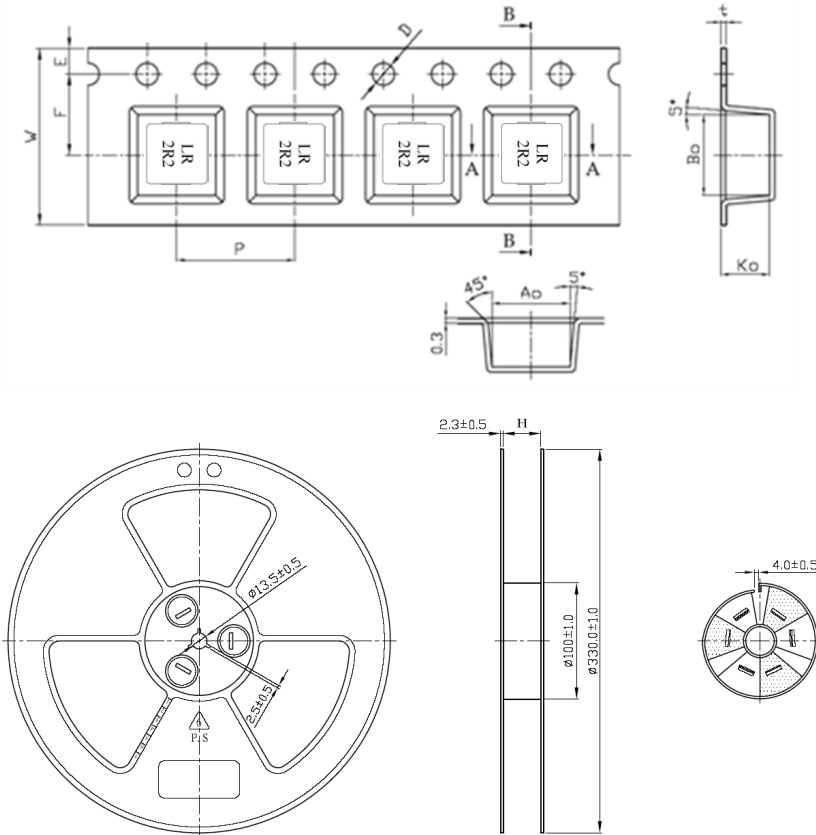

A0	5.3
B0	5.5
K0	3.3
P	8.0
t	0.4
W	12
E	1.75
F	5.5
D	1.5

Dimension: mm

## REFLOW PROFILE:

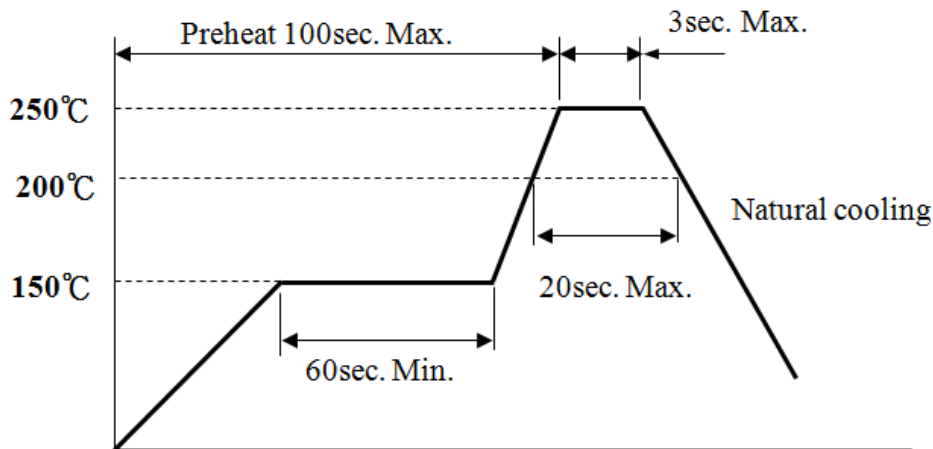

**ATTENTION:** Abracon Corporation's products are COTS – Commercial-Off-The-Shelf products; suitable for Commercial, Industrial and, where designated, Automotive Applications. Abracon's products are not specifically designed for Military, Aviation, Aerospace, Life-dependant Medical applications or any application requiring high reliability where component failure could result in loss of life and/or property. For applications requiring high reliability and/or presenting an extreme operating environment, written consent and authorization from Abracon Corporation is required. Please contact Abracon Corporation for more information.

ABRACON IS  
ISO 9001:2008  
CERTIFIED



Visit [www.abracon.com](http://www.abracon.com) for Terms & Conditions of Sale

Revised: 11.13.11

30332 Esperanza, Rancho Santa Margarita, California 92688  
tel 949-546-8000 | fax 949-546-8001 | [www.abracon.com](http://www.abracon.com)