

# LOW PROFILE SHIELDED SMD CHIP POWER INDUCTOR



3.0 x 3.0 x 1.5mm

ASPI-0315FS

MSL level: 2 (This product is packed with dry packaging)



RoHS  
Compliant

## FEATURES:

- Small size and low profile: 1.5mm
- Small DCR and high rated current
- High reliability to mechanical stress
- Magnetically shielded by magnetic powder molding
- Suitable for RoHS reflow profile

## APPLICATIONS:

- Mobile phones
- MP3 & 4 and other portable communication equipment
- Digital cameras.

## ELECTRICAL SPECIFICATIONS:

Abracon P/N:	ASPI-0315FS Series
Operating Temperature & Humidity:	-25°C to +120°C (Including self generated heat)
Storage Temperature & Humidity:	-10°C to +40°C, 30% to 70% RH

Part Number	Inductance	Inductance Tolerance	DCR	DCR Tolerance	Saturation Current	Temperature Rise Current
Units	μH	%	mΩ	%	A	A
Symbol	L	M, N	DCR		Isat	Irms
ASPI-0315FS-1R0	1.0	N	28	±30%	2.3	2.3
ASPI-0315FS-1R5	1.5	N	37		2.1	2.1
ASPI-0315FS-2R2	2.2	M	58		1.62	2
ASPI-0315FS-2R7	2.7	M	60		1.5	1.95
ASPI-0315FS-3R3	3.3	M	75		1.35	1.8
ASPI-0315FS-4R7	4.7	M	100	±20%	1.20	1.6
ASPI-0315FS-5R6	5.6	M	120		1.00	1.4
ASPI-0315FS-6R8	6.8	M	150		0.97	1.3
ASPI-0315FS-100	10	M	220		0.8	1.1
ASPI-0315FS-150	15	M	300		0.65	1
ASPI-0315FS-220	22	M	475		0.55	0.8
ASPI-0315FS-330	33	M	650		0.45	0.7
ASPI-0315FS-390	39	M	850		0.4	0.5
ASPI-0315FS-470	47	M	1100		0.35	0.45
ASPI-0315FS-680	68	M	1700		0.3	0.35
ASPI-0315FS-820	82	M	1900	0.27	0.32	
ASPI-0315FS-101	100	M	2100	0.25	0.3	

## Test Conditions

1. Inductance is measured in HP-4285A Precision LCR Meter.
2. RDC is measured in DU-5011 milli ohm meter.(or equivalent).
3. Isat : Based on inductance change ( $\Delta L/L_0 : \leq -30\%$ )
4. Irms : Based on temperature rise ( $\Delta T : 40^\circ\text{C TYP.}$  )
5. Test Freq: 100KHz, 1Vrms

## OPTIONS AND PART IDENTIFICATION

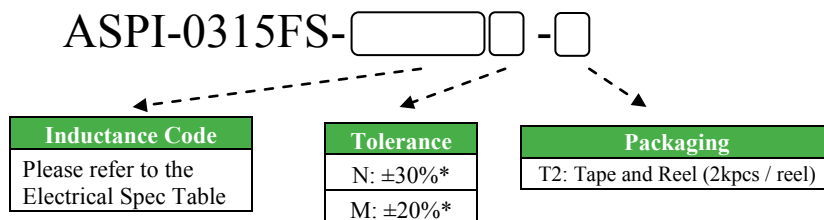

\*N for L = 1.0 ~ 1.5μH  
\*M for L = 2.2 ~ 100μH



**ABRACON**  
CORPORATION

Visit [www.abracon.com](http://www.abracon.com) for Terms & Conditions of Sale **Revised: 11.22.11**  
30332 Esperanza, Rancho Santa Margarita, California 92688  
tel 949-546-8000 | fax 949-546-8001 | [www.abracon.com](http://www.abracon.com)

# LOW PROFILE SHIELDED SMD CHIP POWER INDUCTOR

ASPI-0315FS



**RoHS**  
Compliant

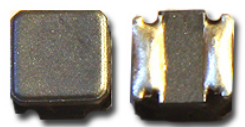

3.0 x 3.0 x 1.5mm

## OUTLINE DRAWING:

### Mechanical Dimensions

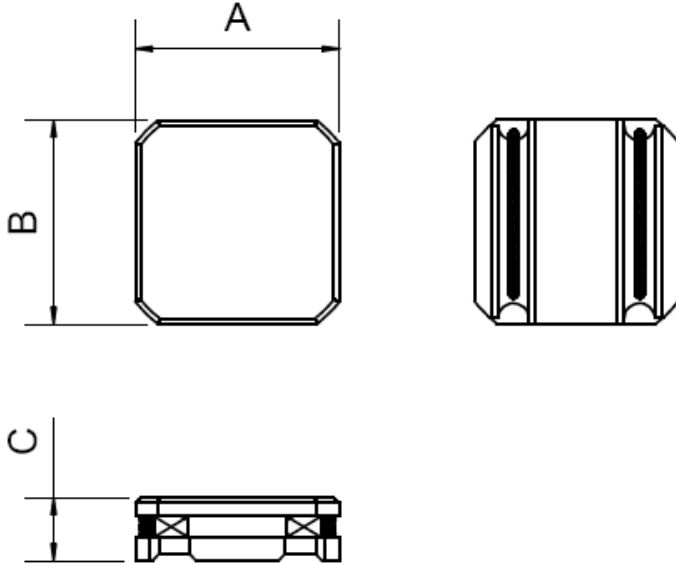

A	B	C Max.
3.0±0.1	3.0±0.1	1.5

### Circuit Schematic

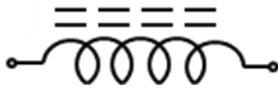

No Polarity

### Recommended Land Pattern

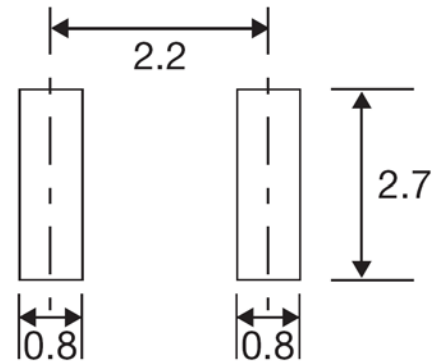

### Materials

Dimension: mm

No	Part Name	Material
1	Drum core	Ni-Zn Ferrite
2	Terminals	Copper alloy, Sn
3	Coil	Cu/UEW
4	Adhesive	Epoxy base resin
	Magnetic powder	Ni-Zn Ferrite



# LOW PROFILE SHIELDED SMD CHIP POWER INDUCTOR

ASPI-0315FS



RoHS  
Compliant

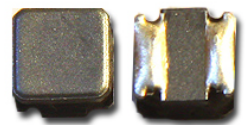

3.0 x 3.0 x 1.5mm

## TAPE & REEL:

T2: 2,000pcs / reel

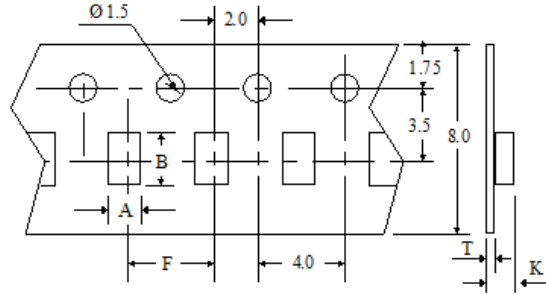

A	3.15
B	3.15
K	1.55
F	4
T	0.25

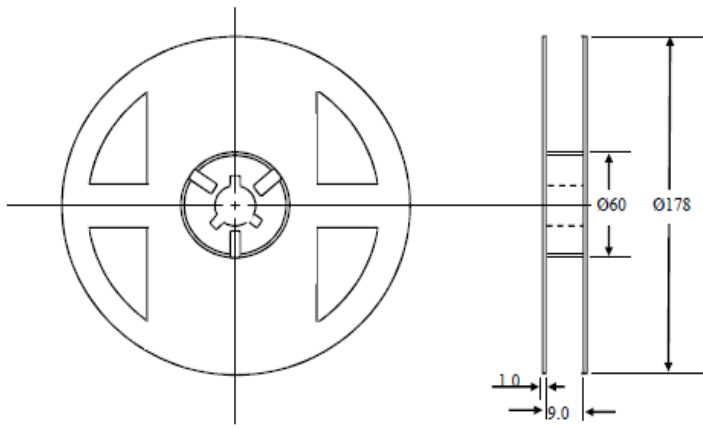

Dimension: mm

## REFLOW PROFILE:

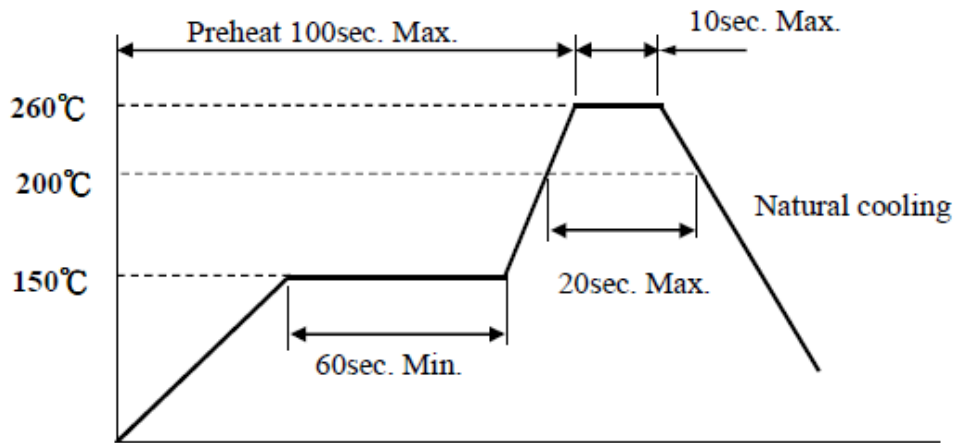

**ATTENTION:** Abracon Corporation's products are COTS – Commercial-Off-The-Shelf products; suitable for Commercial, Industrial and, where designated, Automotive Applications. Abracon's products are not specifically designed for Military, Aviation, Aerospace, Life-dependant Medical applications or any application requiring high reliability where component failure could result in loss of life and/or property. For applications requiring high reliability and/or presenting an extreme operating environment, written consent and authorization from Abracon Corporation is required. Please contact Abracon Corporation for more information.

ABRACON IS  
ISO9001:2008  
CERTIFIED



**ABRACON**  
CORPORATION

Visit [www.abracon.com](http://www.abracon.com) for Terms & Conditions of Sale **Revised: 11.22.11**  
30332 Esperanza, Rancho Santa Margarita, California 92688  
tel 949-546-8000 | fax 949-546-8001 | [www.abracon.com](http://www.abracon.com)